

# Torino

Design by BoConcept

Samvejledning - Assembly Instructions - Montageanleitung - Instructions d'assemblage - Instrucciones de montaje

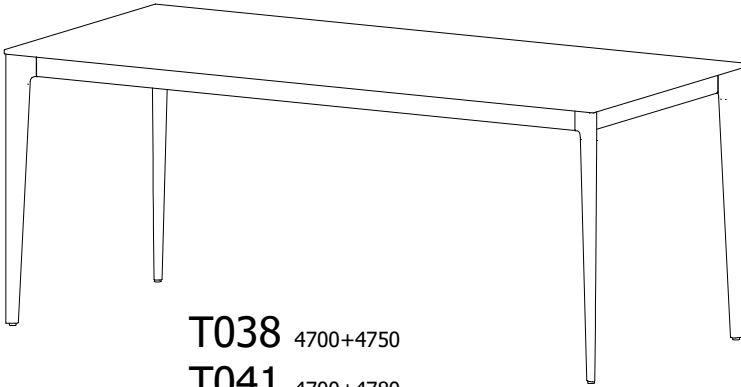

**T038** 4700+4750  
**T041** 4700+4780  
74,1x180x80cm

Example



**T037** 4710+4760  
**T040** 4710+4790  
74,1x120x80cm

Model 4700

Korpus - Korpus - Carcasse - Carcasse

Model 4710

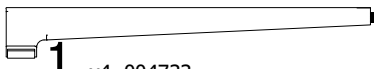

**1** x4 004733

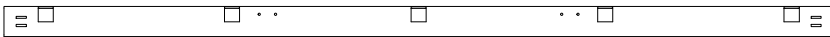

**2** x2 004734



**3** x2 004735



**4** x2 004736

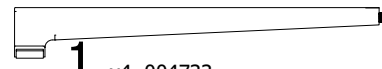

**1** x4 004733

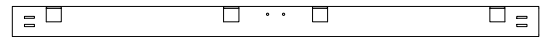

**5** x2 004737



**3** x2 004735



**4** x1 004736

Beslag - Beschlage - Fittings - Set de montage

4700 - No. 937000010  
4710 - No. 937000011

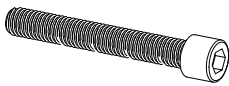

**A x 4**  
970001592  
M8x55mm



**B x 4**  
970000884  
D20, 8,4x1,4 mm



**C x 4**  
970000905  
Spring washer D14 d8,3x3,0 mm



**D x 8 / 4**  
970001482  
M6x10mm

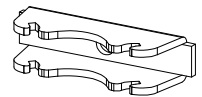

**E x 4**  
004805



**F x 12/14**  
970001599  
Screw ma M4x11 mm



**G x 12/14**  
970001600  
Bush M4 D8x8



**H x 1**  
4mm

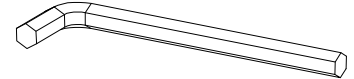

**J x 1**  
6mm

Model 4780

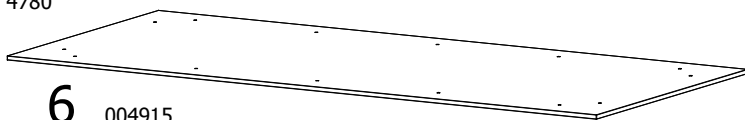

**6** 004915

Example

Model 4790

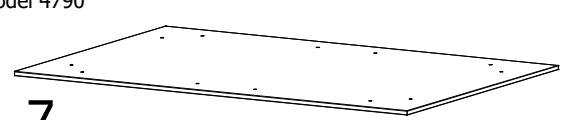

**7** 004916

Model 4750

For Contract use only!

Model 4760

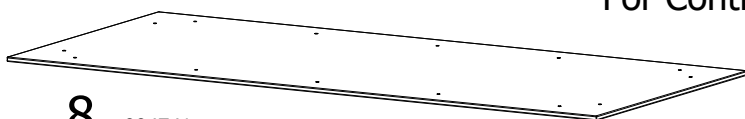

**8** 004741

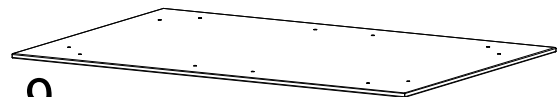

**9** 004742

FIG. 1

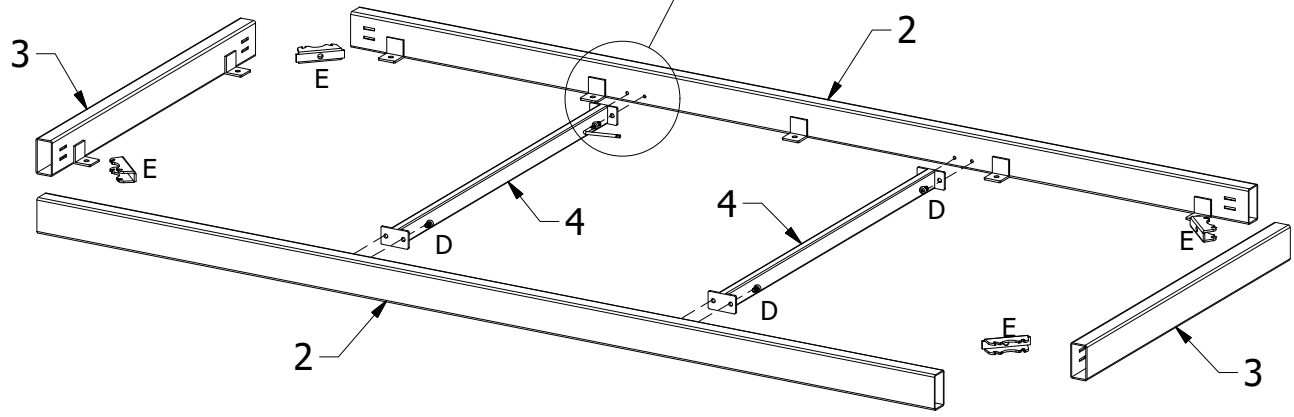
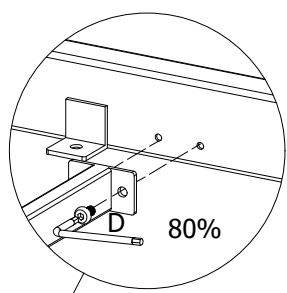
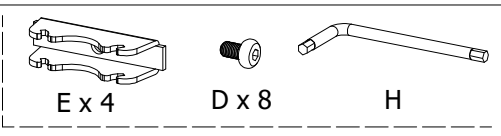
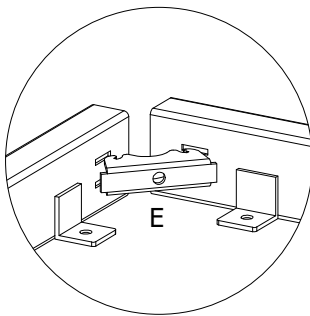

FIG. 2

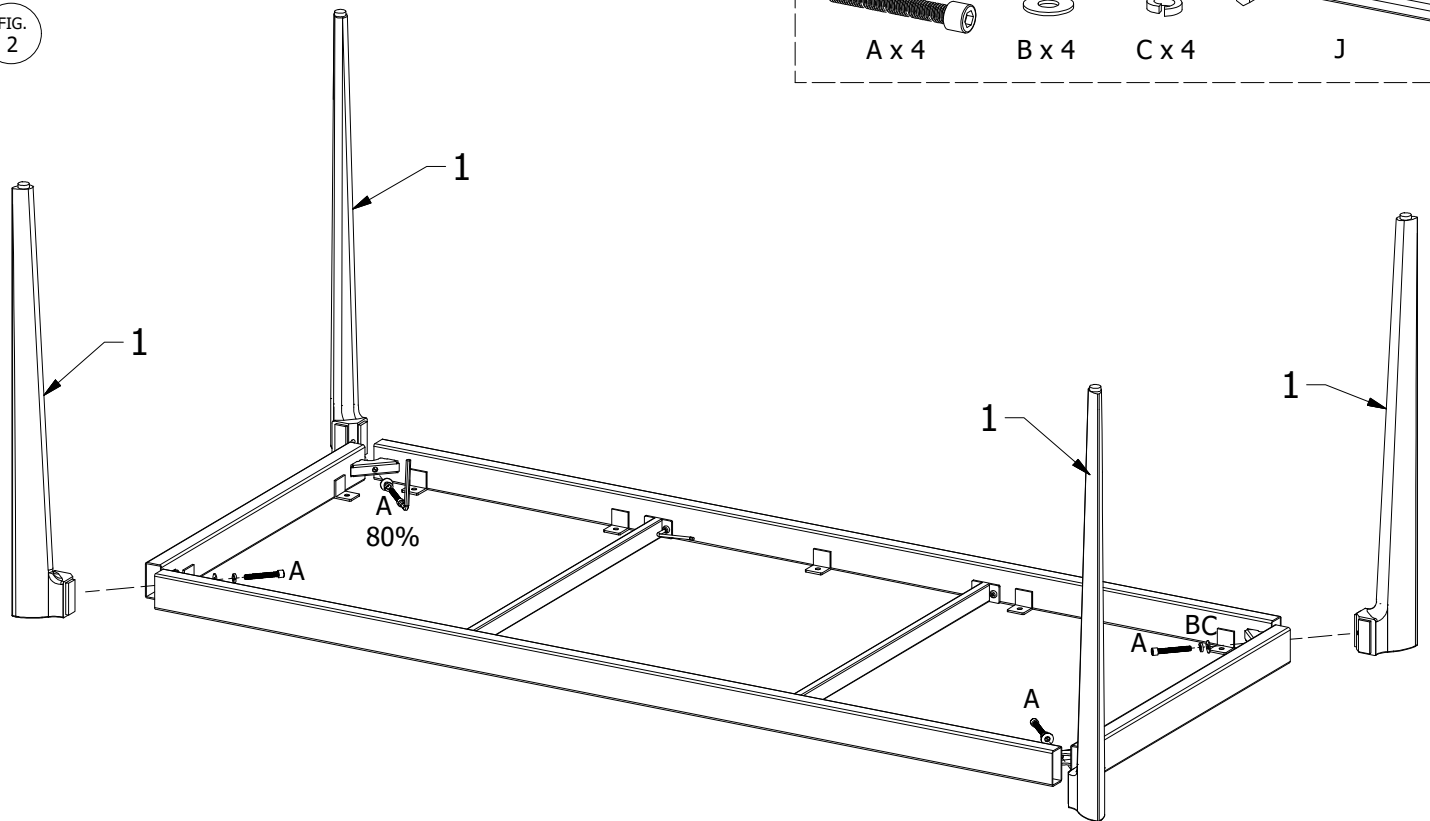
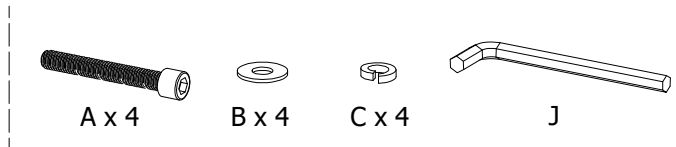

FIG. 3

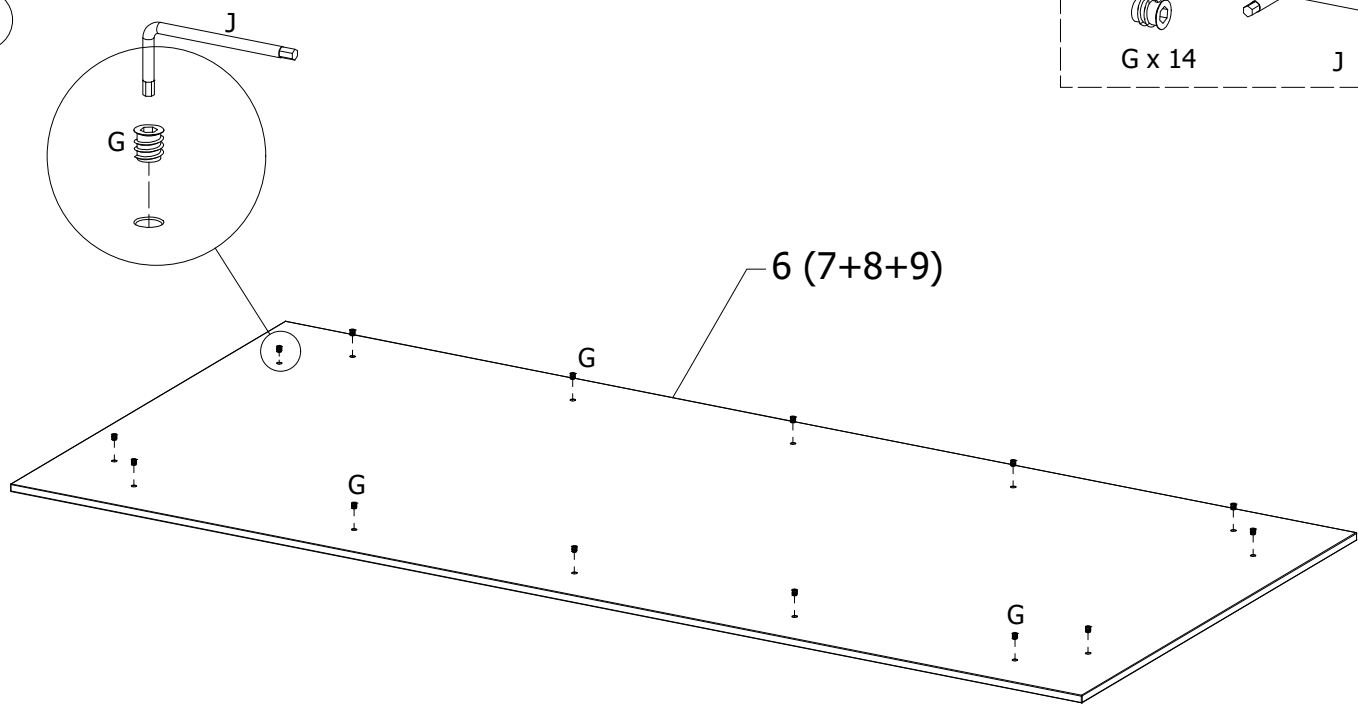
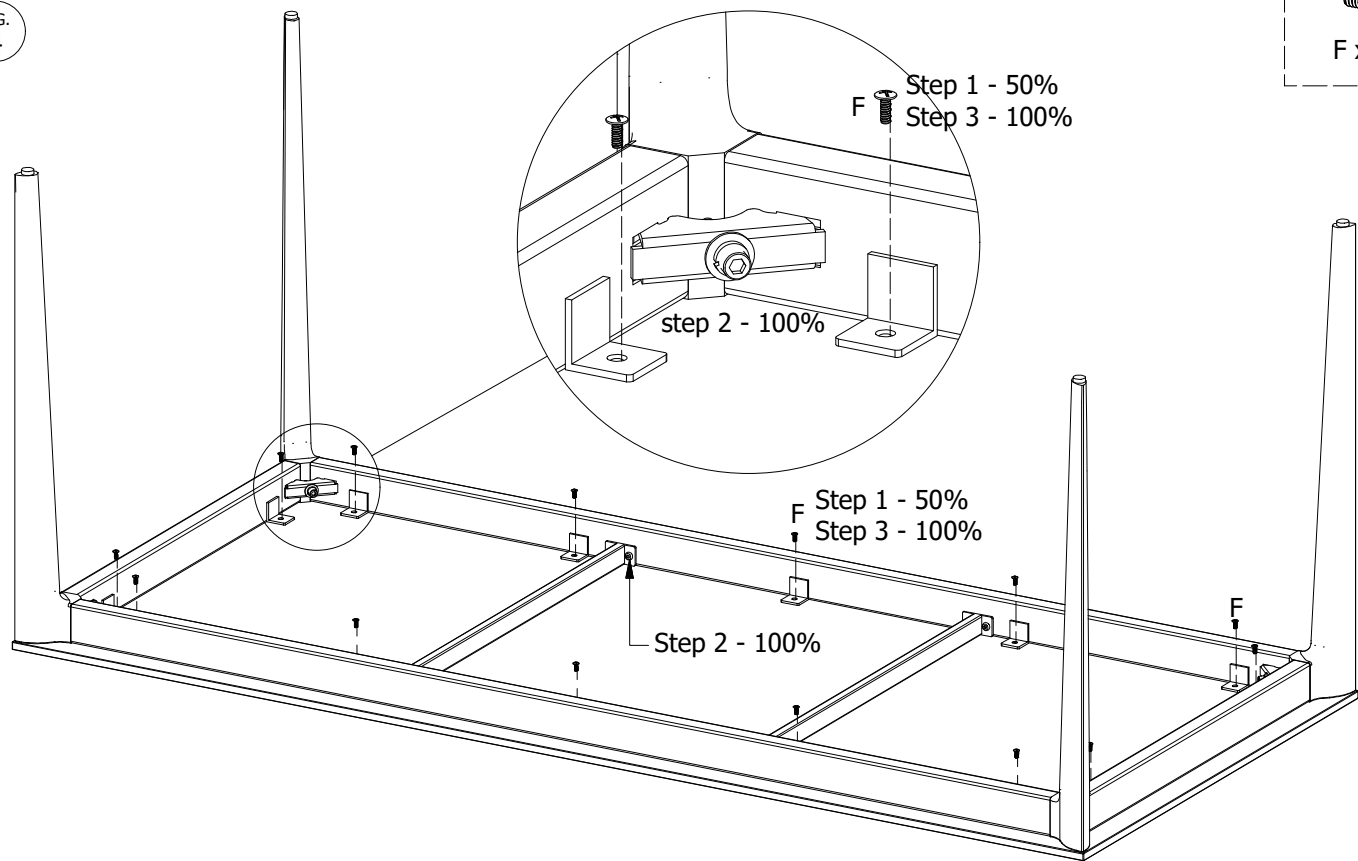
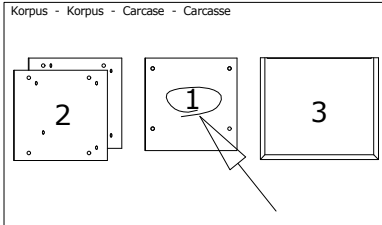







FIG. 4



**DK** Ved reklamation oplyses følgende:  
**D** Im Reklamationsfall, bitte folgendes erläutern:  
**US** In case of claims, please state the following:  
**F** En cas de réclamation, veuillez indiquer:  
**NL** Bij service volgense mededelen  
**E** En caso de reclamación, indicar lo siguiente:  
**P** No caso de reclamação, por favor indique o seguinte:  
**JP** お気づきの点等ございましたら、以下の点をお知らせください。

Example!



Beslag - Fittings - Beschläge - Set de Montage		
 A X 8 1972000014	 B X 12 1972000004	 C X 4 1979110830
 D X 2 1970120000	 H X 2 1978504022	 J X 8 1978204210