

Adelaide Barstool

Design by BoConcept

Samvejledning - Assembly Instructions - Montageanleitung - Instructions d'assemblage - Instrucciones de montaje

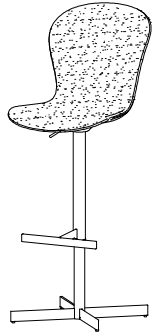

402-B006
2250 + 2130
<1x2250, 1x2130>

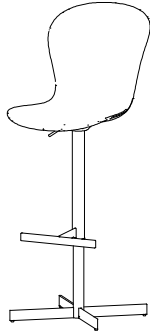

402-B007
2250 + 2110
<1x2250, 1x2110>

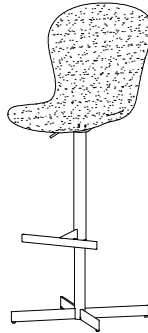

402-B008
2250 + 2170
<1x2250, 1x2170>

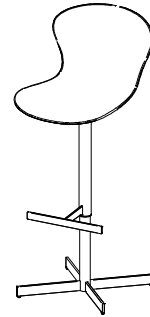

402-B011
2250 + 0090
<1x2250, 1x0090>

100kg/220lb



2251 - col 1

4
004145

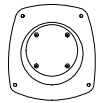

1952 - col 2

1
003105

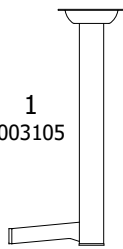

2
003106



3
003771

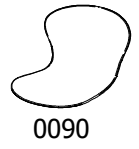
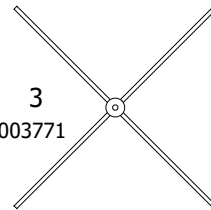

0090

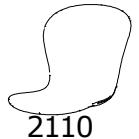

2110

Beslag - Beschlage - Fittings - Set de montage

2251 - col 1
Fittingbag: 937000066

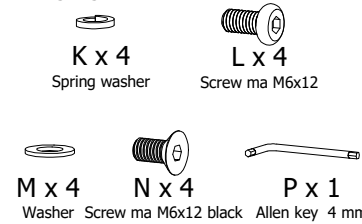

1952 - col 2 Fittingbag: 937000022

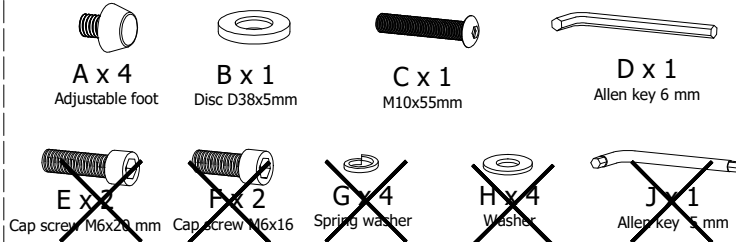

2130



2170

FIG. 1

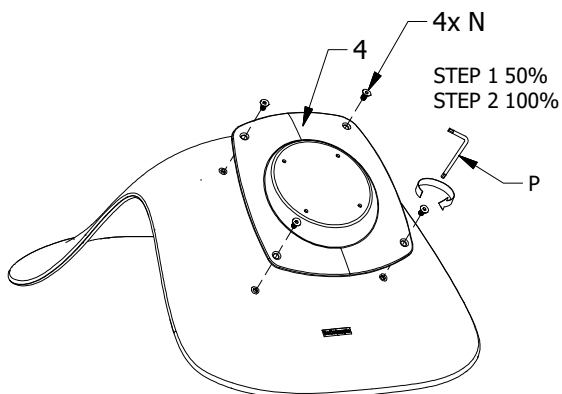

FIG. 2

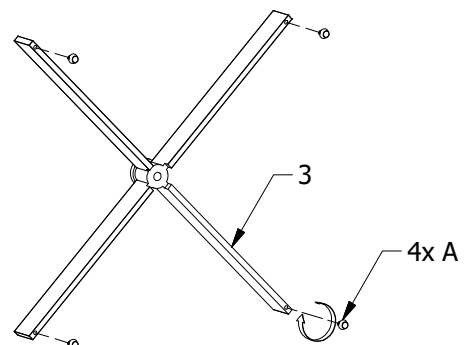
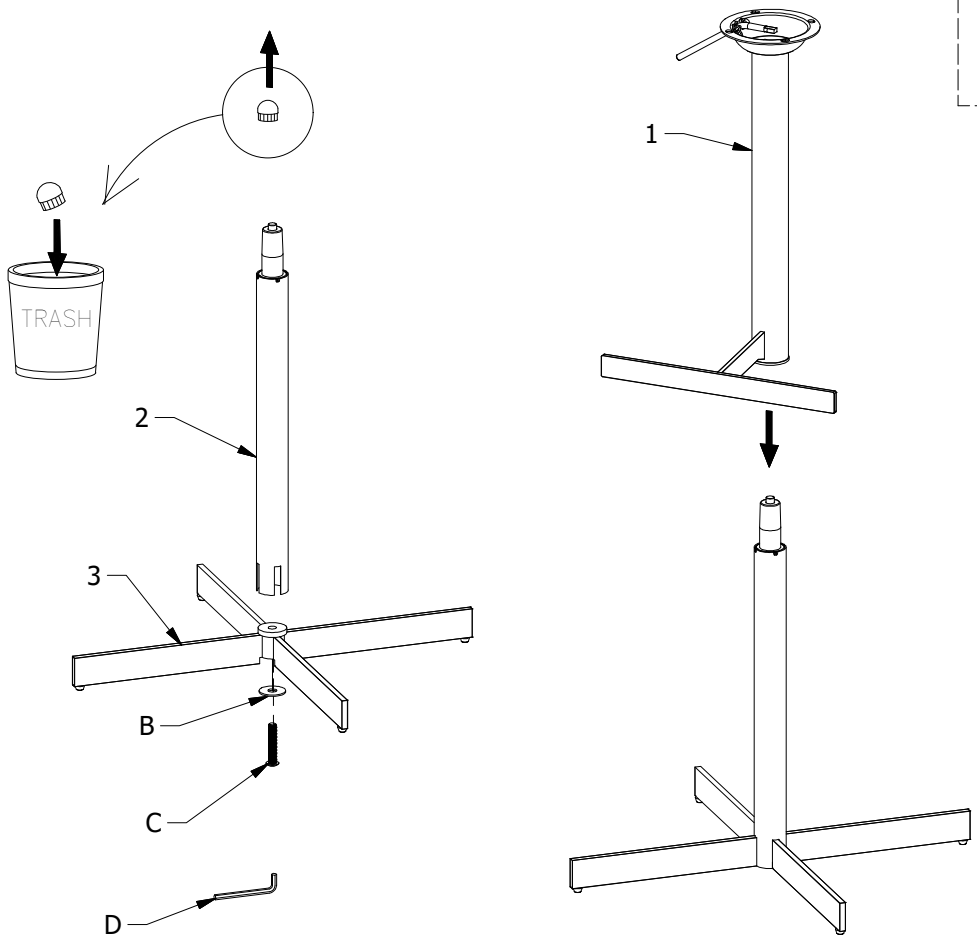

FIG. 3









- 
B x 1
- 
C x 1
- 
D x 1

FIG. 4



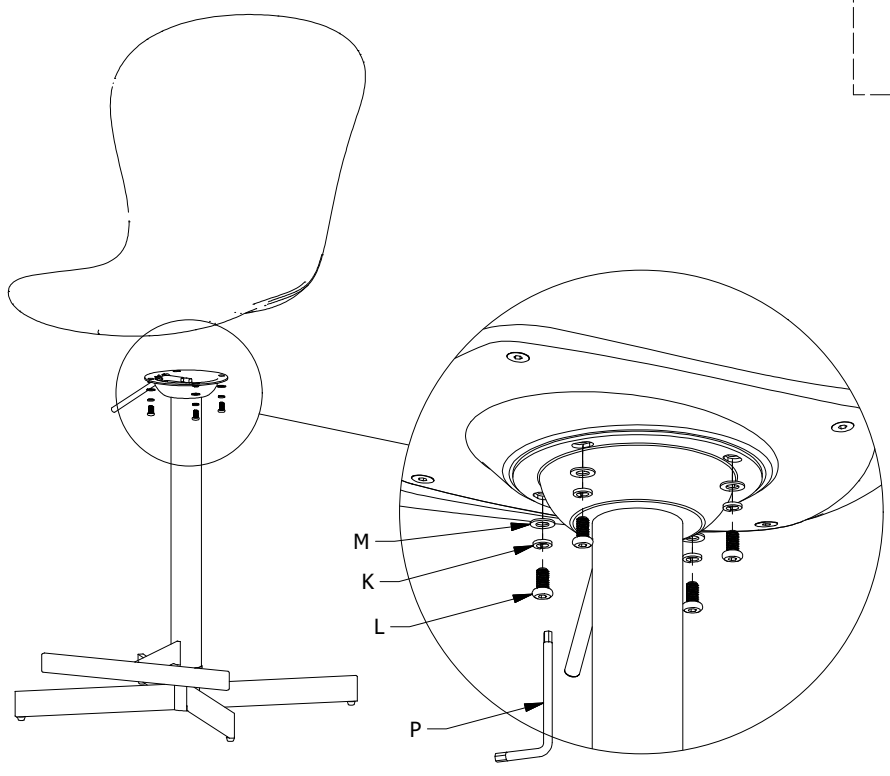



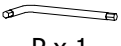
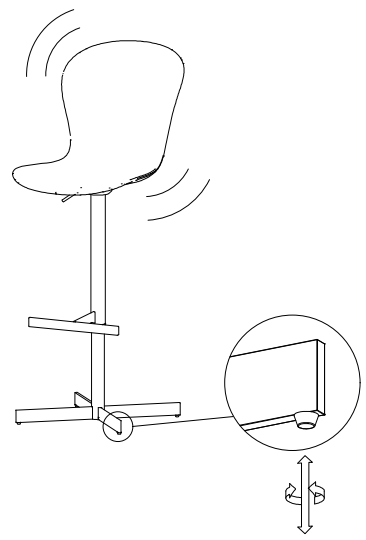

- 
K x 4
- 
L x 4
- 
M x 4
- 
P x 1

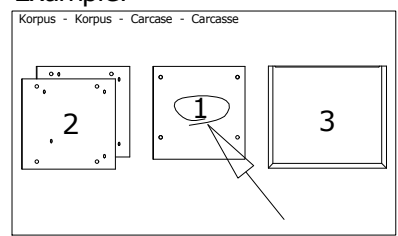

! DK Ved reklamation oplyses følgende:
 D Im Reklamationsfall, bitte folgendes erläutern:
 US In case of claims, please state the following:
 F En cas de réclamation, veuillez indiquer:
 NL Bij service volgene mededelen
 E En caso de reclamación, indicar lo siguiente:
 P No caso de reclamação, por favor indique o seguinte:
■ JP お気づきの点等ございましたら、以下の点をお知らせください。

Example!



- Beslag - Fittings - Beschläge - Set de Montage
- 
AX 8
1972000014
 - 
BX 12
1972000004
 - 
CX 4
1979110830
 - 
DX 2
1970120000
 - 
HX 2
1978504022
 - 
JX 8
1978204210