

New York

Design by BoConcept

Samvejledning - Assembly Instructions - Montageanleitung - Instructions d'assemblage - Instrucciones de montaje

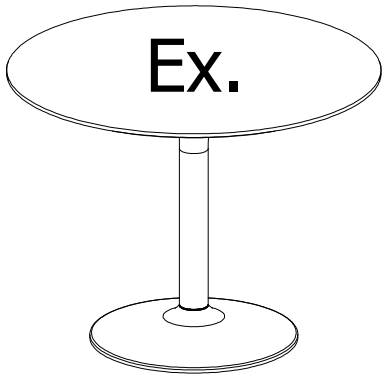

370-T060

370-1680 and 370-1700
Max 40 kg.
75,1 x 99 cm

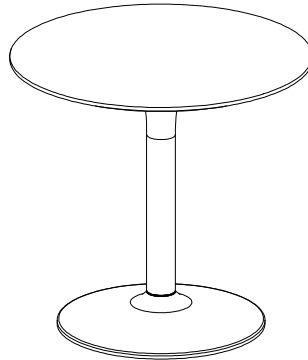

370-T061

370-1680 and 370-1710
Max 30 kg
75,1 x 80 cm

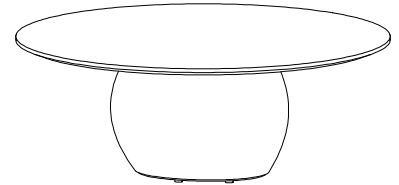

370-AD16

370-1080 and 1700
max. 20 kg
38 x 99 x 99 cm.

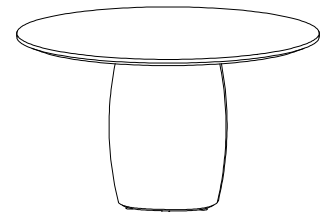

370-AD17

370-1060 and 1710
Max 30 kg.
45x80x80 cm

370-1700

005449 Wood
005549 Ceramic

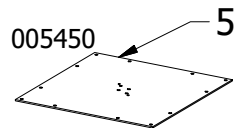
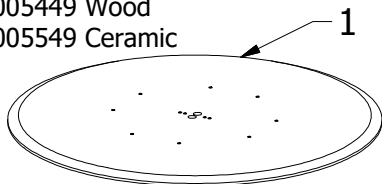

370-1710

005448 Wood
005550 Ceramic

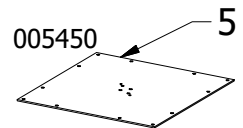
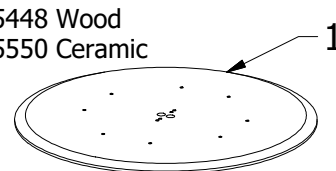

370-1700 and 370-1710 Beslag - Beschläge - Fittings - Set de montage



D x 10
970001600

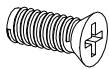

E x 10
970001768

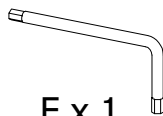

F x 1
970001692

370-1681

005399

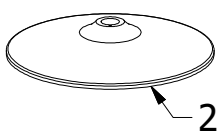

370-1682

005400

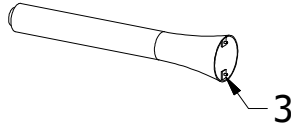

005401 x 2

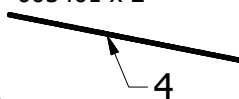

Værktøj - Werkzeuge - Tools - Outils

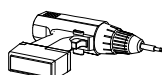
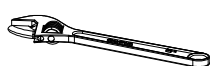

370-1682 937000044

Beslag - Beschläge - Fittings - Set de montage



A x 2
970001205
M10 Nut



B x 2
970001741
M10 Lock nut

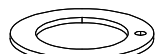

C x 1
005418



~~**D x 4**~~
~~970001758~~



~~**E x 2**~~
~~970001759~~



~~**F x 2**~~
~~970001760~~

FIG. 1

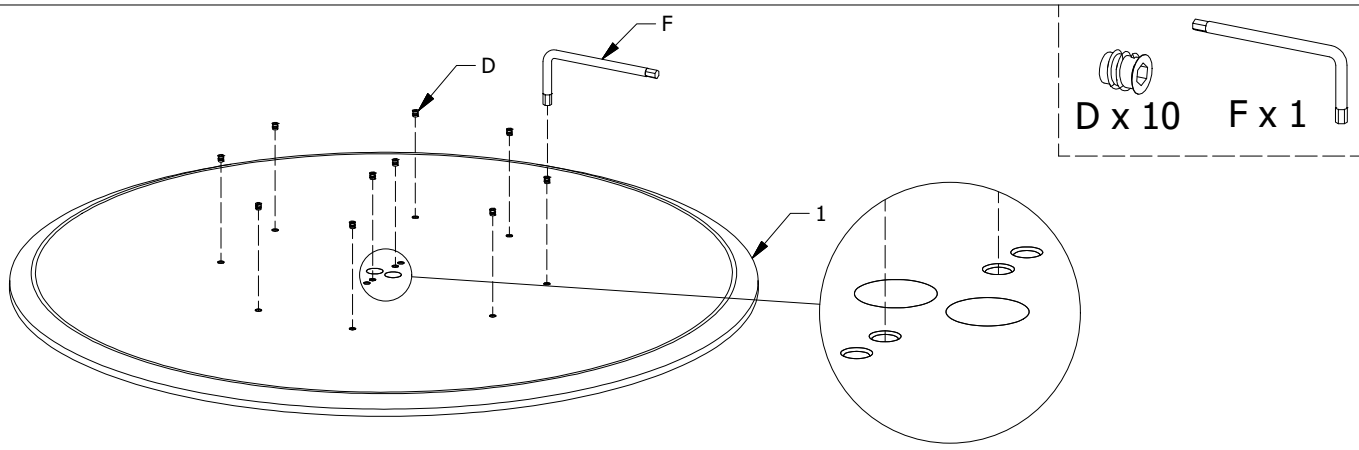
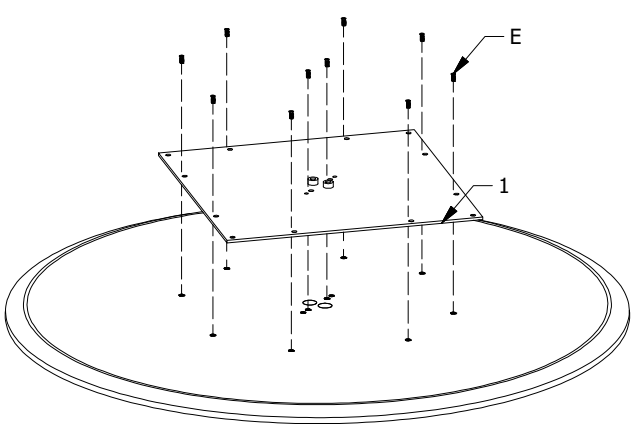

FIG. 2



370-AD16 / 370-AD17

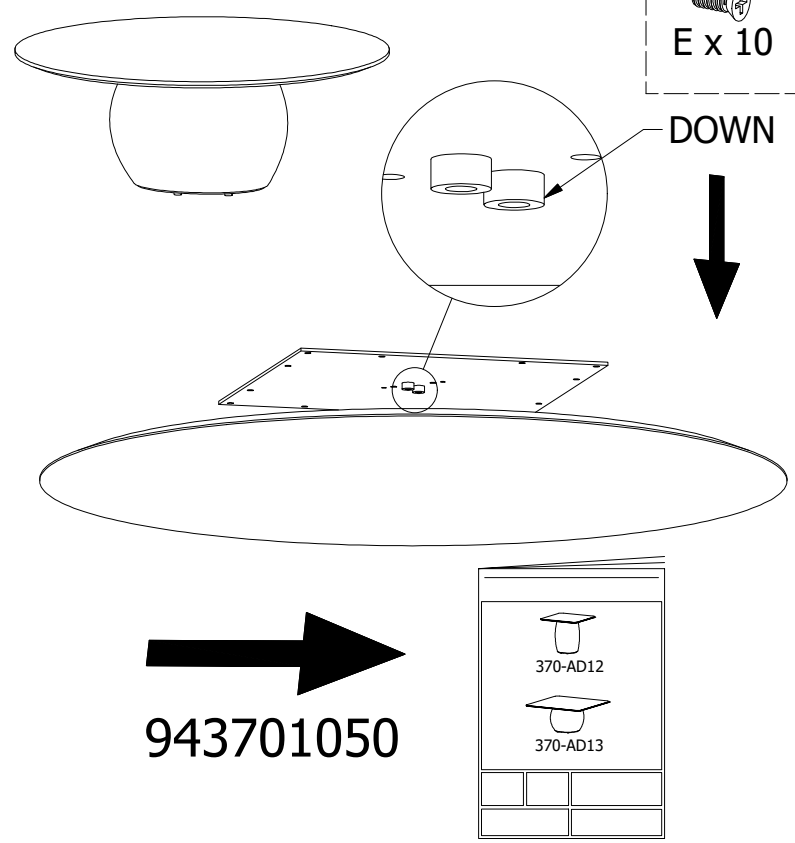
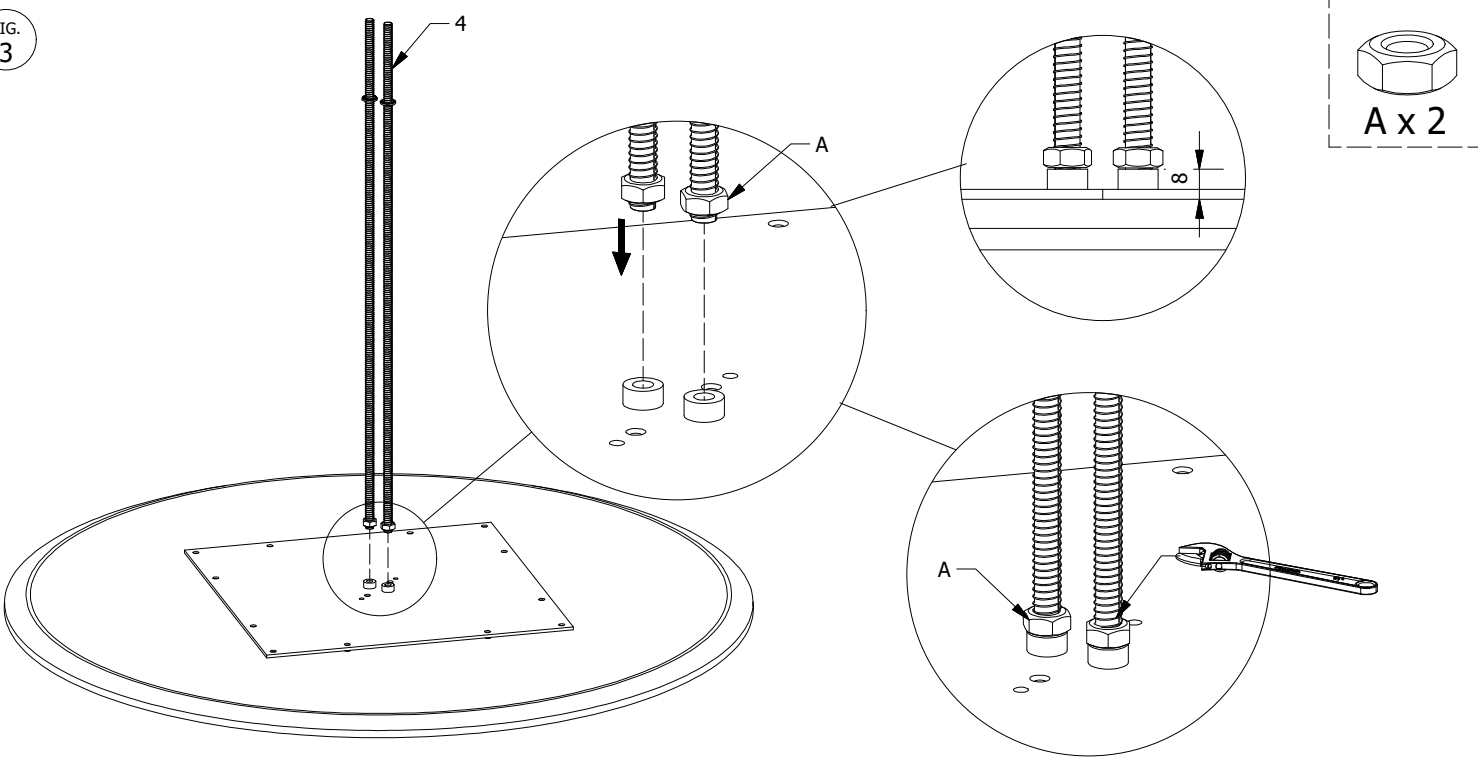
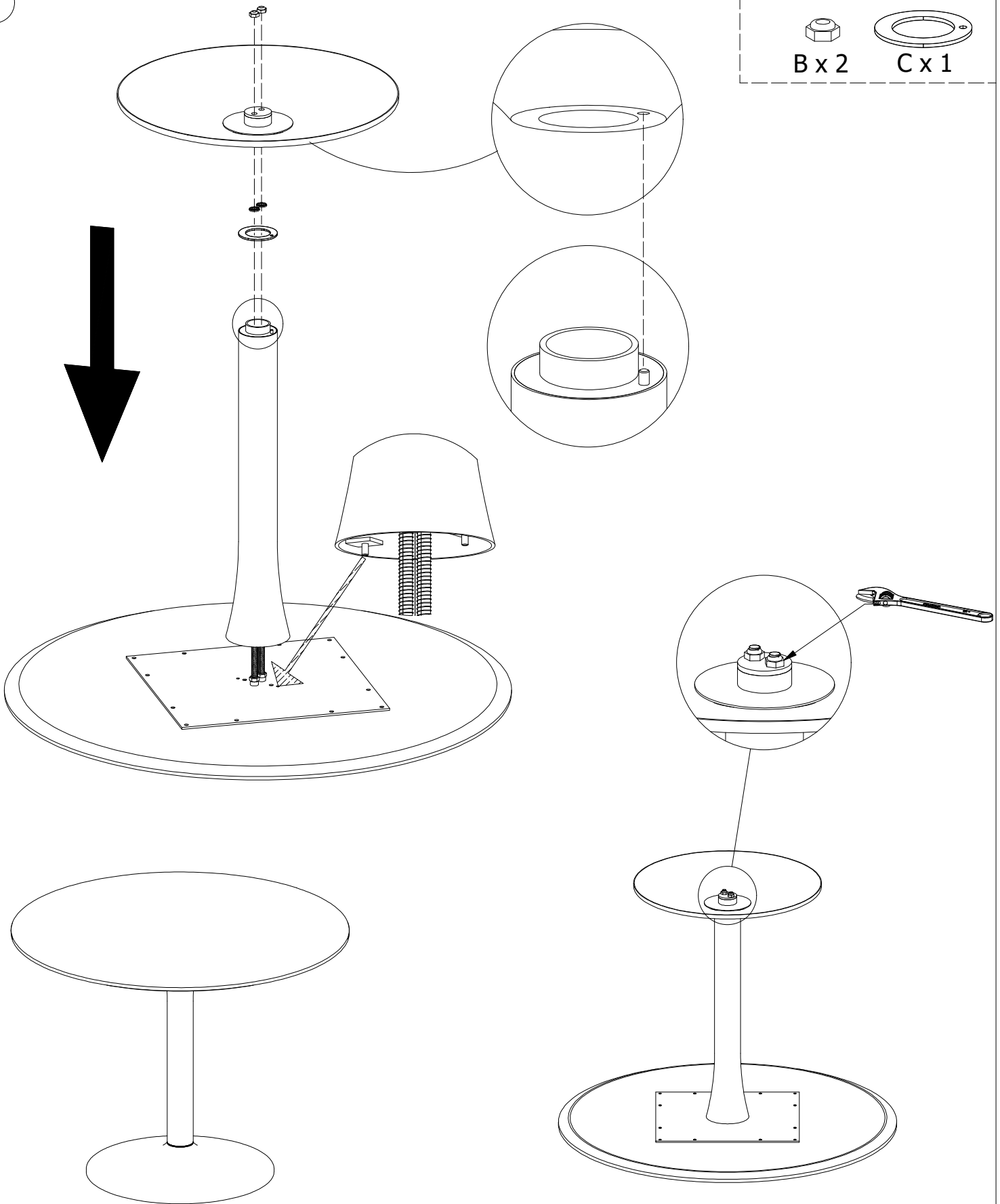

FIG. 3









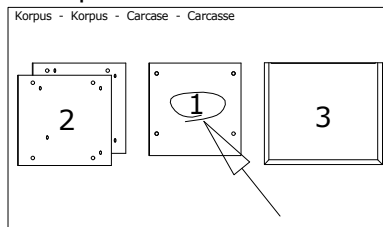

DK Ved reklamation oplyses følgende:
 D Im Reklamationsfall, bitte folgendes erläutern:
 US In case of claims, please state the following:
 F En cas de réclamation, veuillez indiquer:
 NL Bij service volgene mededelen
 E En caso de reclamación, indicar lo siguiente:
 P No caso de reclamação, por favor indique o seguinte:
 JP お気づきの点等ございましたら、以下の点をお知らせください。

Example!



Beslag - Fittings - Beschläge - Set de Montaje		
 A X 8 1972000014	 B X 12 1972000004	 C X 4 1979110830
 D X 2 1970120000	 H X 2 1978504022	 J X 8 1978204210