

# Adelaide dining chair

Design by BoConcept

Samvejledning - Assembly Instructions - Montageanleitung - Instructions d'assemblage - Instrucciones de montaje

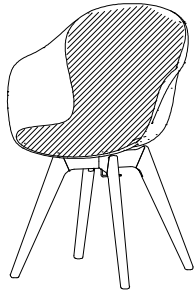

**402-D061**  
1x2200, 1x2180  
86,0x60,0x57,5

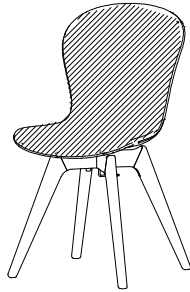

**402-D062**  
1x2200, 1x2130  
86,0x45,0x57,5

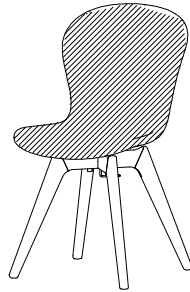

**402-D063**  
1x2200, 1x2170  
86,0x45,0x57,5

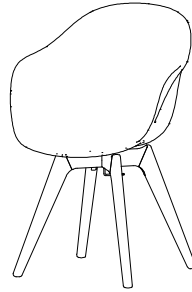

**402-D064**  
1x2200, 1x2100  
86,0x45,0x57,5

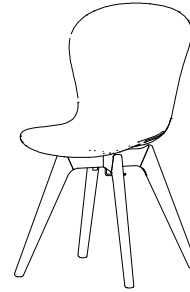

**402-D065**  
1x2200, 1x2110  
86,0x45,0x57,5

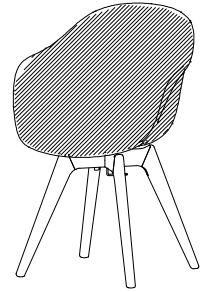

**402-D066**  
1x2200, 1x2240  
86,0x45,0x57,5

Colli 2

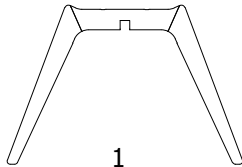

**1**  
004764

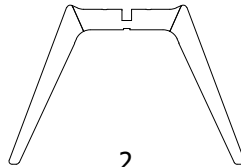

**2**  
004765



**3**  
004145



**4**  
004939

Beslag - Beschläge - Fittings - Set de montage  
no. 937000001



**A x 4**  
979900213  
Screw ma M6x12



**B x 4**  
970001368  
Distance Washer



**C x 1**  
970001597  
Hex screw M6x35



**D x 4**  
970001378  
M6x73 mm



**E x 4**  
970001598  
Screw flh 4x30 black



**F x 1**  
1979300004  
Allen key 4 mm

FIG.  
1

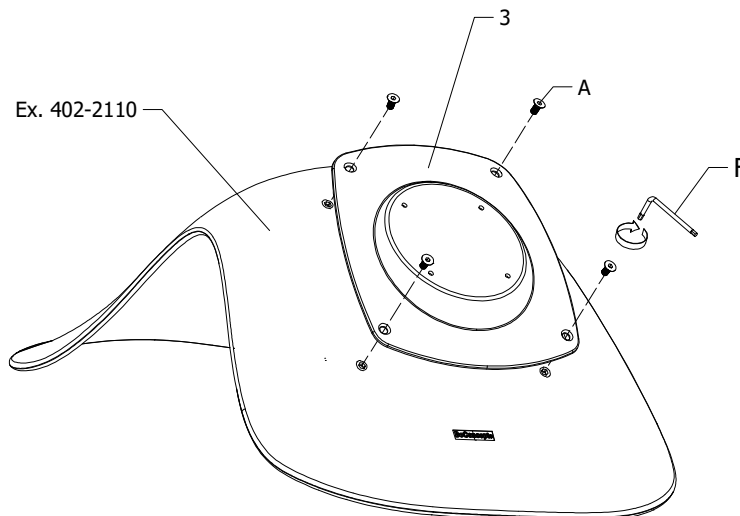

**A x 4**



**F**

125kg/275lb



FIG. 2

EX. 402-D065

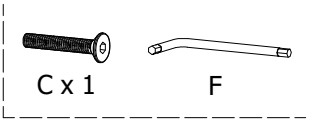

Step 1 = 50%

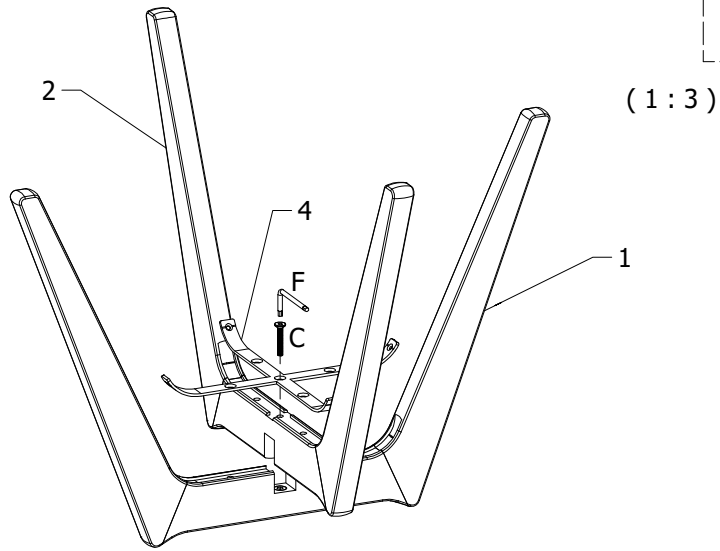
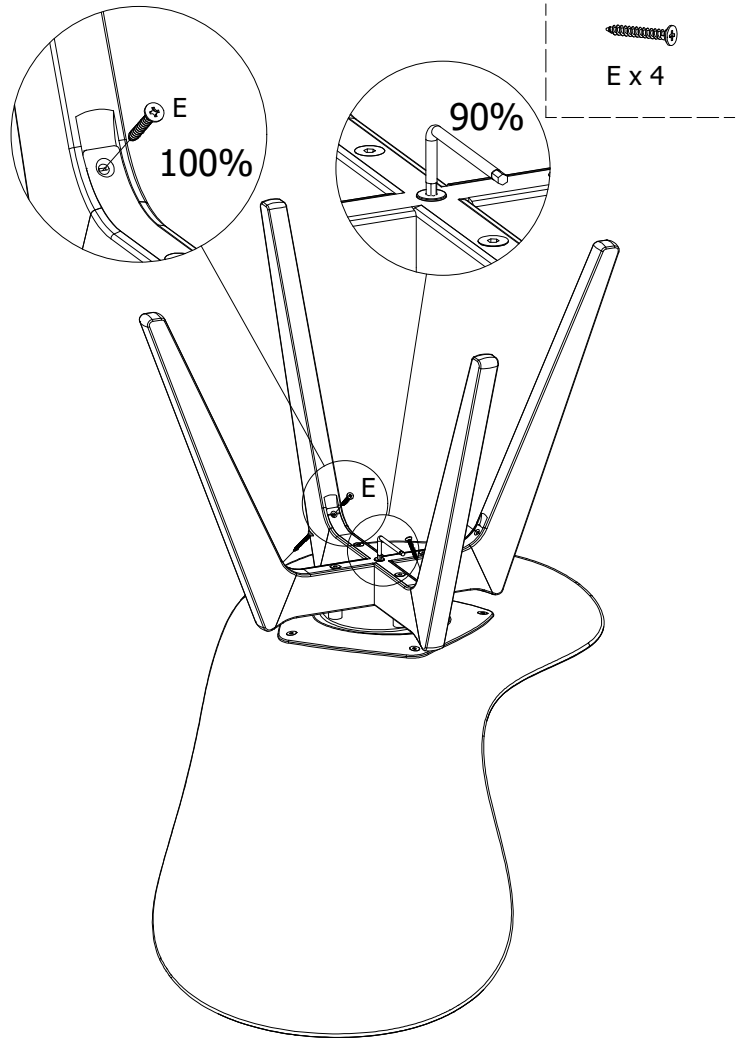
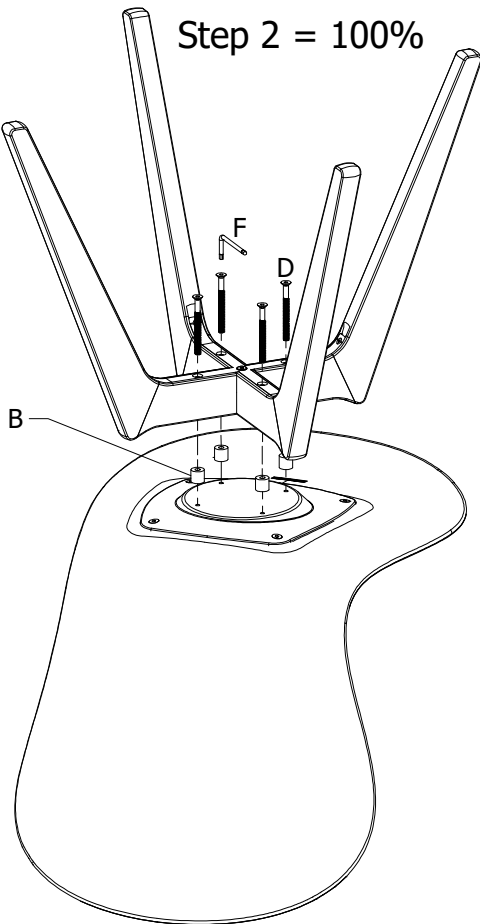

FIG. 3

Step 2 = 100%



DK Ved reklamation oplyses følgende:

D Im Reklamationsfall, bitte folgendes erläutern:

US In case of claims, please state the following:

F En cas de réclamation, veuillez indiquer:

NL Bij service volgense mededelen

E En caso de reclamación, indicar lo siguiente:

P No caso de reclamação, por favor indique o seguinte:

JP お気づきの点等ございましたら、以下の点をお知らせください。

Example!

Korpus - Korpus - Carcase - Carcasse

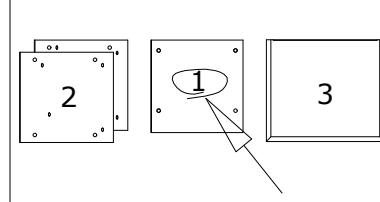

Beslag - Fittings - Beschläge - Set de Montage

