

Torino Outdoor

Design by BoConcept

Samvejledning - Assembly Instructions - Montageanleitung - Instructions d'assemblage - Instrucciones de montaje

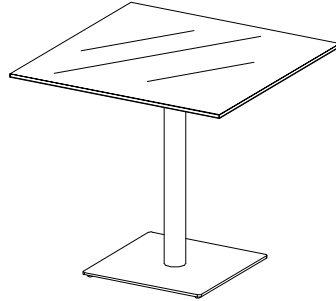

T003 1520 + 1570
74x80x80cm (Max 20kg)

Model 1520

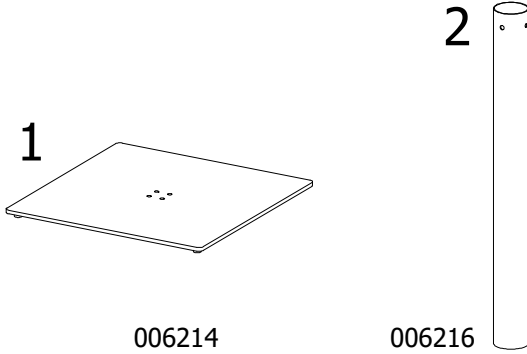

Model 1570

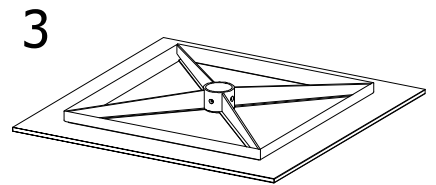

Sparepart bag

937000129



x4

970001774

Beslag - Beschlage - Fittings - Set de montage

No. 937000130



A x 4
M6x16 mm



B x 1
4mm

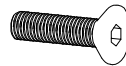

C x 4
M8 x 30mm



D x 1
5mm

FIG. 1
Step 1

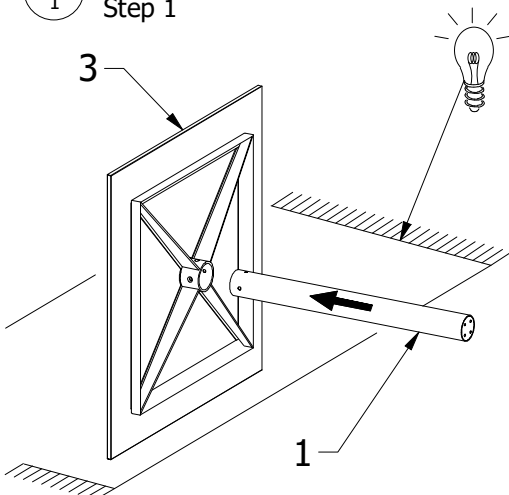

Step 2

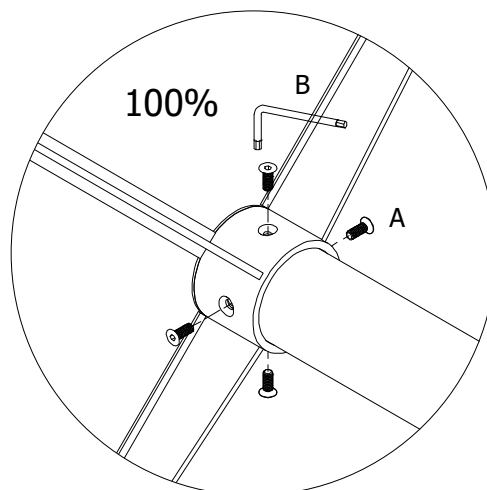

A x 4



B

FIG. 2

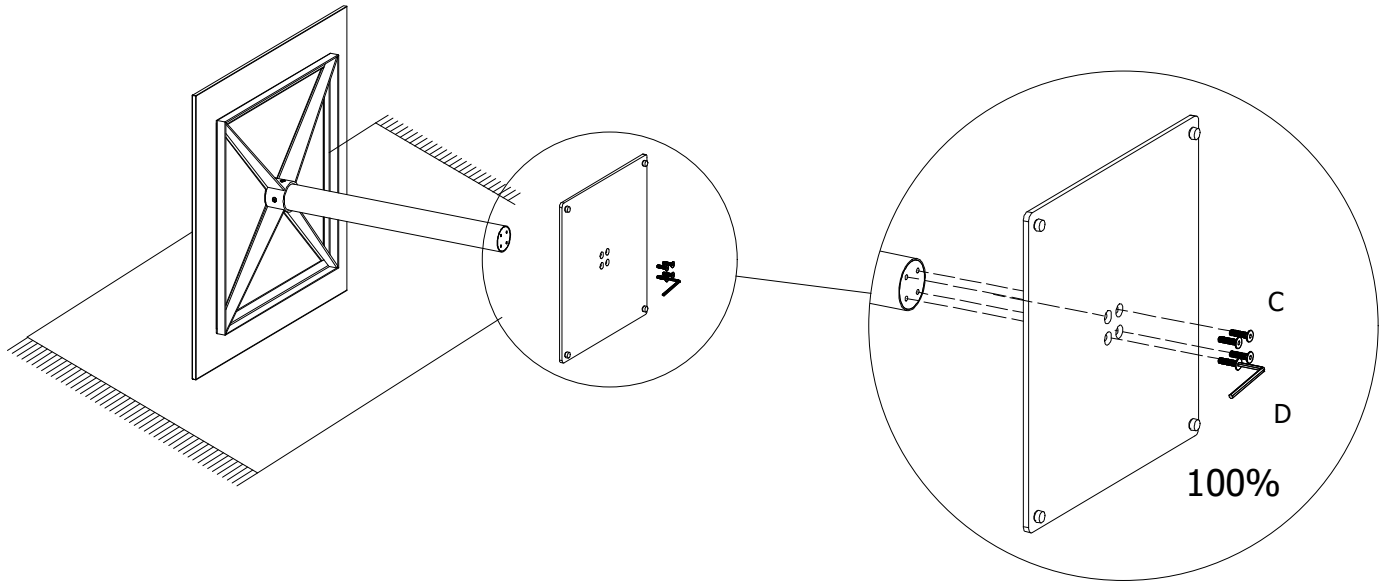
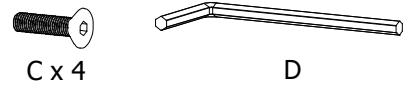
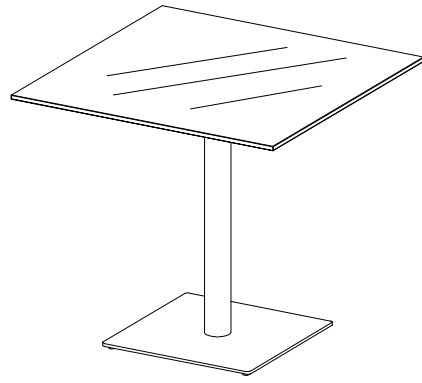
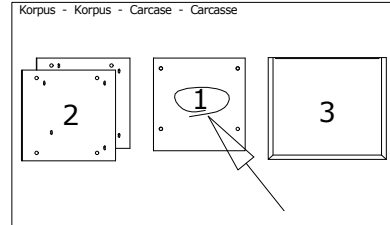







FIG. 3



DK Ved reklamation oplyses følgende:
 D Im Reklamationsfall, bitte folgendes erläutern:
 US In case of claims, please state the following:
 F En cas de réclamation, veuillez indiquer:
 NL Bij service volgene mededelen
 E En caso de reclamación, indicar lo siguiente:
 P No caso de reclamação, por favor indique o seguinte:
 JP お気づきの点等ございましたら、以下の点をお知らせください。

Example!



Beslag - Fittings - Beschläge - Set de Montage		
 A X 8 1972000014	 B X 12 1972000004	 C X 4 1979110830
 D X 2 1970120000	 H X 2 1978504022	 J X 8 1978204210