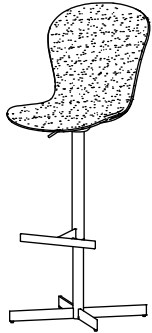


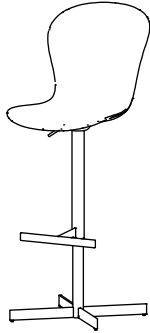
Adelaide Barstool

Design by BoConcept

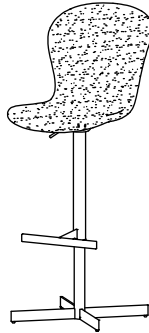
Samvejledning - Assembly Instructions - Montageanleitung - Instructions d'assemblage - Instrucciones de montaje



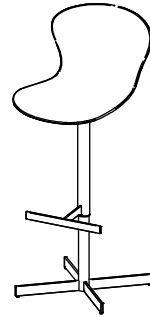
402-B006
2250 + 2130
<1x2250, 1x2130>



402-B007
2250 + 2110
<1x2250, 1x2110>



402-B008
2250 + 2170
<1x2250, 1x2170>



402-B011
2250 + 0090
<1x2250, 1x0090>

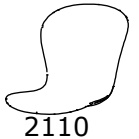
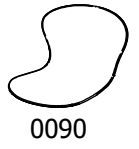
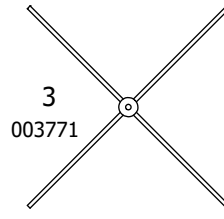
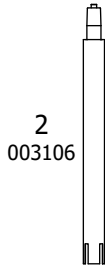
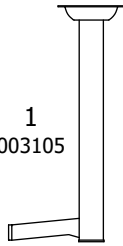
100kg/220lb



2251 - col 1



1952 - col 2



Beslag - Beschlage - Fittings - Set de montage

2251 - col 1
Fittingbag: 937000066

1952 - col 2 Fittingbag: 937000022



FIG. 1

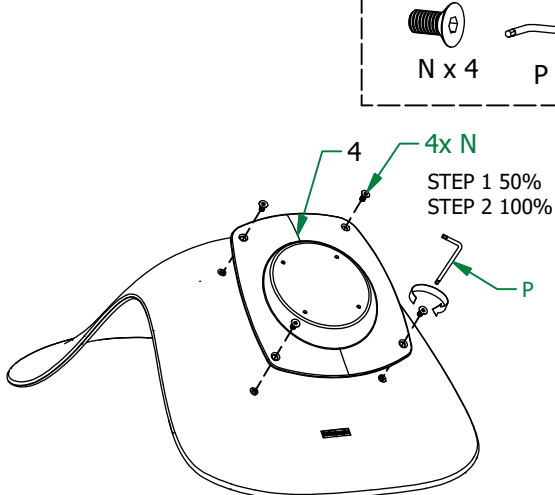
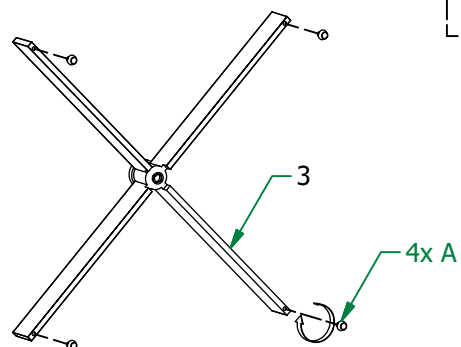


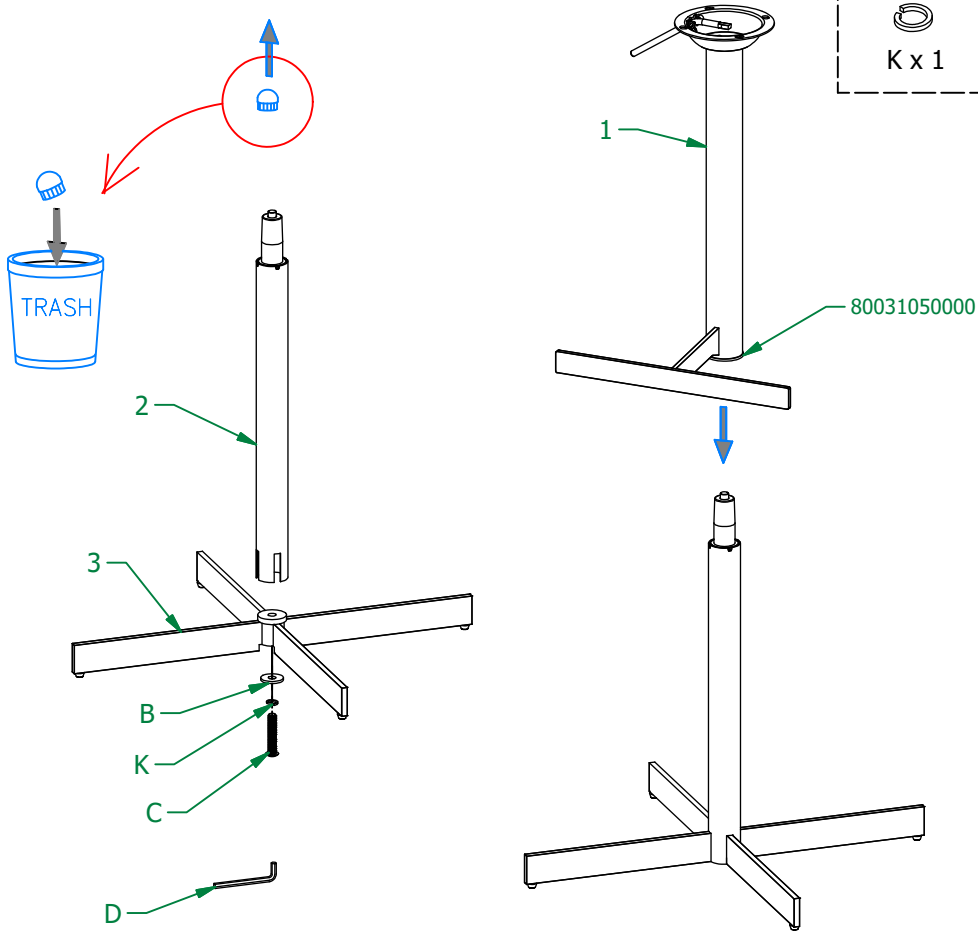
FIG. 2



Sparepart bag no. 937000078



FIG. 3







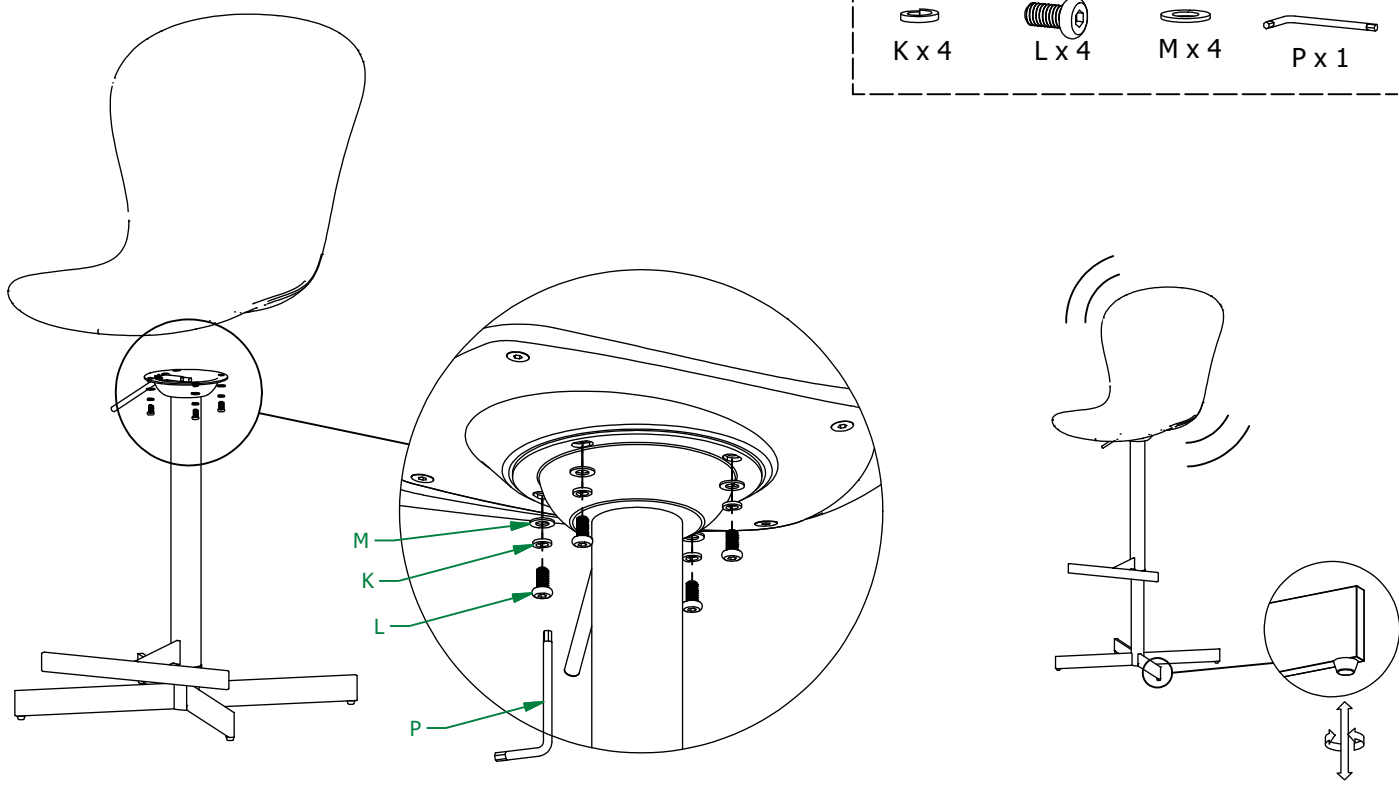

- 
K x 1
- 
B x 1
- 
C x 1
- 
D x 1

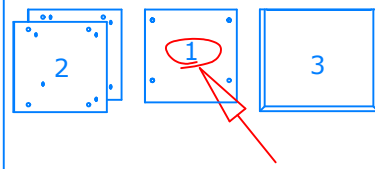


















FIG. 4



- 
K x 4
- 
L x 4
- 
M x 4
- 
P x 1


DK Ved reklamation oplyses følgende:
D Im Reklamationsfall, bitte folgendes erläutern:
US In case of claims, please state the following:
F En cas de réclamation, veuillez indiquer:
NL Bij service volgene mededelen
E En caso de reclamación, indicar lo siguiente:
P No caso de reclamação, por favor indique o seguinte:
JP お気づきの点等ございましたら、以下の点をお知らせください。

Example!

Korpus - Korpus - Carcasse - Carcasse	Beslag - Fittings - Beschläge - Set de Montage						
	<table style="width: 100%; text-align: center;"> <tr> <td style="padding: 5px;">  A X 8 <small>1972000014</small> </td> <td style="padding: 5px;">  B X 12 <small>1972000004</small> </td> <td style="padding: 5px;">  C X 4 <small>1979110830</small> </td> </tr> <tr> <td style="padding: 5px;">  D X 2 <small>1970120000</small> </td> <td style="padding: 5px;">  H X 2 <small>1978504022</small> </td> <td style="padding: 5px;">  J X 8 <small>1978204210</small> </td> </tr> </table>	 A X 8 <small>1972000014</small>	 B X 12 <small>1972000004</small>	 C X 4 <small>1979110830</small>	 D X 2 <small>1970120000</small>	 H X 2 <small>1978504022</small>	 J X 8 <small>1978204210</small>
 A X 8 <small>1972000014</small>	 B X 12 <small>1972000004</small>	 C X 4 <small>1979110830</small>					
 D X 2 <small>1970120000</small>	 H X 2 <small>1978504022</small>	 J X 8 <small>1978204210</small>					