

# Volani

Design by BoConcept

Samvejledning - Assembly Instructions - Montageanleitung - Instructions d'assemblage - Instrucciones de montaje

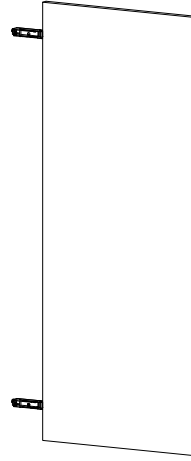

**710**

102,1x39,7x1,6 cm

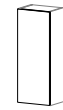

5050  
1x710

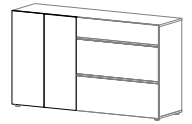

2900  
2x710

Korpus - Korpus - Carcase - Carcasse  
Col. 1



Beslag - Beschläge - Fittings - Set de montage  
Col. 1



A X 2  
970001146



B X 2  
1979000000



C X 2  
970001004



D X 4  
970001027  
4,2x13,5mm



E X 2  
970001016  
Left



F X 2  
970001017  
Right

FIG.  
1



A X 2



B X 2

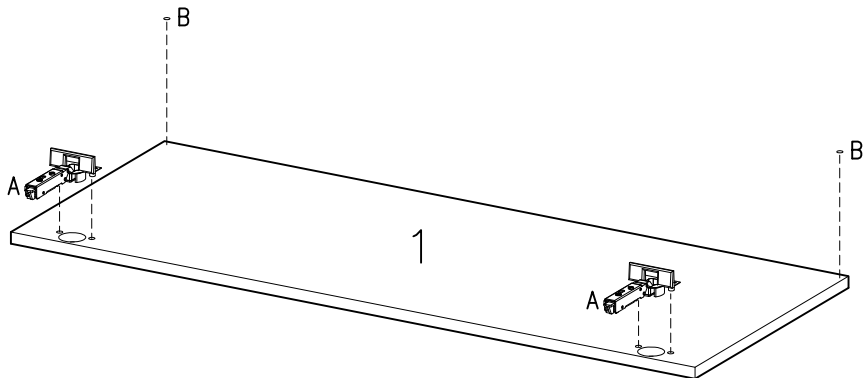
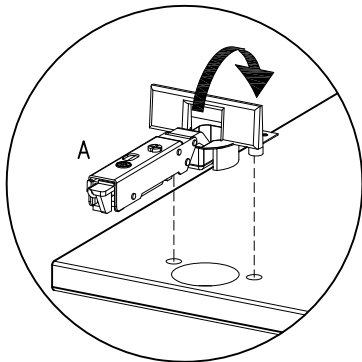
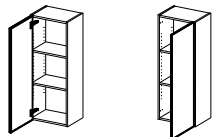





FIG. 2



-   
**C X 2**
-   
**D X 4**  
4,2x13,5mm
-   
**E X 2**  
Left
-   
**F X 2**  
Right

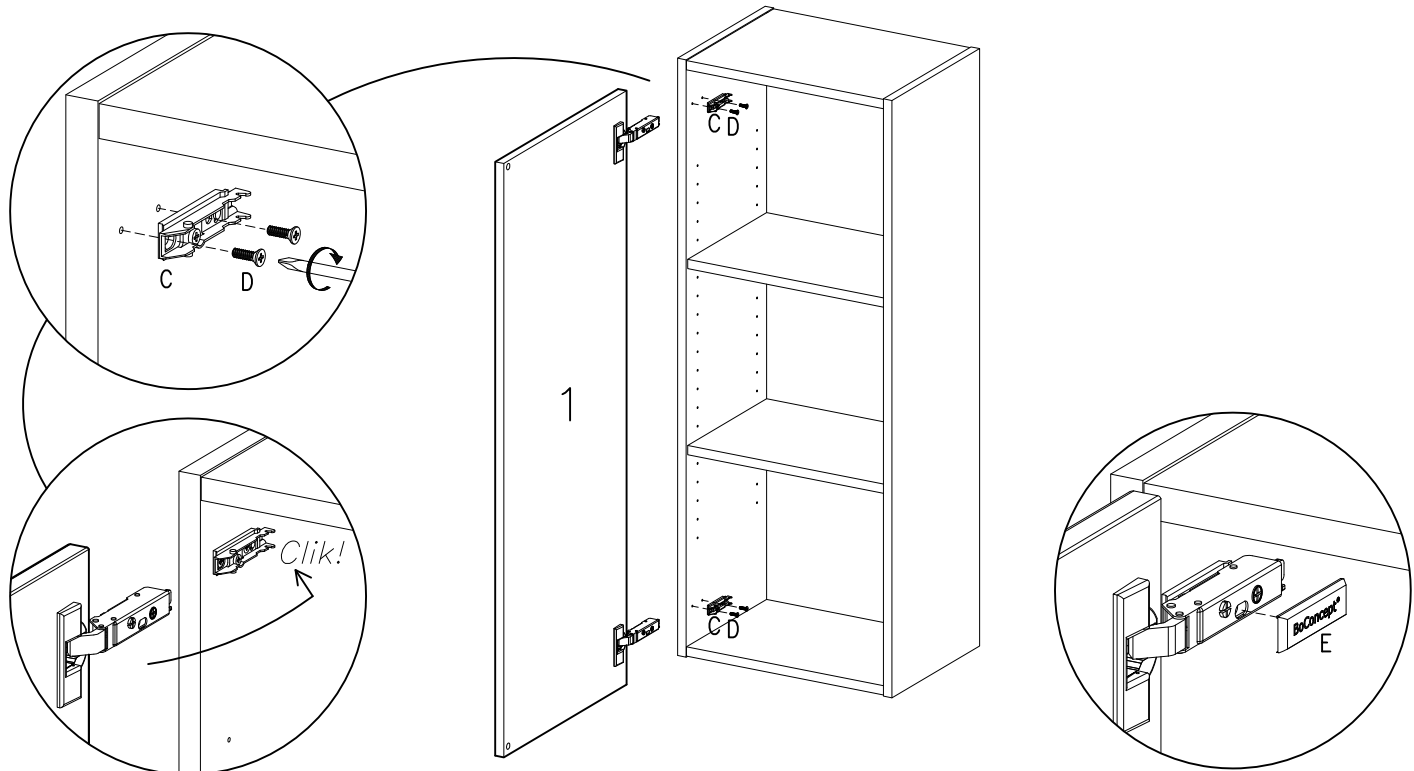
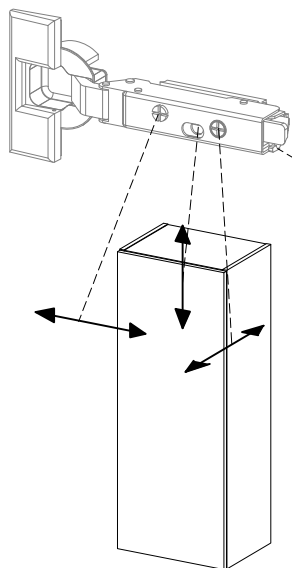
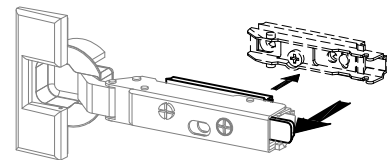
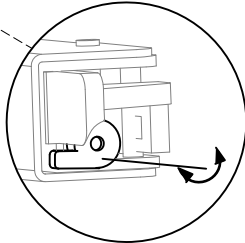

FIG. 3

Lågejustering  
 Justierung der Türen  
 Adjusting the doors  
 Réglage de la porte  
 Bijstelling van de deur  
 Ajuste de las puertas  
 Regolazione delle porte  
 Afiinação da porta



Soft close



- DK Ved reklamation oplyses følgende:  
 D Im Reklamationsfall, bitte folgendes erläutern:  
 US In case of claims, please state the following:  
 F En cas de réclamation, veuillez indiquer:  
 NL Bij service volgene mededelen  
 E En caso de reclamación, indicar lo siguiente:  
 P No caso de reclamação, por favor indique o seguinte:  
 JP お気づきの点等ございましたら、以下の点をお知らせください。

Example!

